



Anclaje macho para cargas altas

**INDEX**

# MTH-A4

Homologado ETE Opt.7. Eje Inoxidable A4. Clip Inoxidable A4

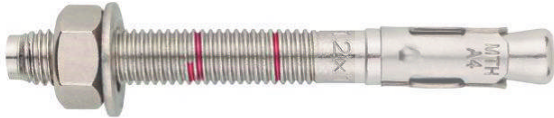

Homologaciones:



Materiales de Uso:

**INOXIDABLE**



Hormigón



Hormigón  
armado



Piedra





Material producto / Recubrimiento:

Inoxidable A4

## CAJA PROFESIONAL

	CÓDIGO	MEDIDA			EAN	PRECIO
	MIA406045	M6 x 45 Ø6	200 pcs.	1200 pcs.	8423533579645	169,561
	MIA406060	M6 x 60 Ø6	200 pcs.	1200 pcs.	8423533579652	184,727
	MIA406080	M6 x 80 Ø6	200 pcs.	1200 pcs.	8423533579669	196,742
	MIA408050	M8 x 50 Ø8	100 pcs.	800 pcs.	8423533579676	204,397
	MIA408075	M8 x 75 Ø8	100 pcs.	600 pcs.	8423533087713	217,056
	MIA408090	M8 x 90 Ø8	100 pcs.	600 pcs.	8423533579683	242,211
	MIA408115	M8 x 115 Ø8	100 pcs.	400 pcs.	8423533579690	318,189
	MIA410070	M10 x 70 Ø10	100 pcs.	400 pcs.	8423533579706	355,488
	MIA410090	M10 x 90 Ø10	100 pcs.	400 pcs.	8423533087706	402,927
	MIA410120	M10 x 120 Ø10	50 pcs.	300 pcs.	8423533579713	489,794
	MIA410150	M10 x 150 Ø10	50 pcs.	200 pcs.	8423533579720	694,624
	MIA412075	M12 x 75 Ø12	50 pcs.	300 pcs.	8423533579737	531,608
	MIA412090	M12 x 90 Ø12	50 pcs.	200 pcs.	8423533579744	535,364
	MIA412110	M12 x 110 Ø12	50 pcs.	200 pcs.	8423533087812	585,631
	MIA412140	M12 x 140 Ø12	50 pcs.	200 pcs.	8423533579751	702,261
	MIA416090	M16 x 90 Ø16	25 pcs.	150 pcs.	8423533579768	1270,189
	MIA416145	M16 x 145 Ø16	25 pcs.	100 pcs.	8423533579775	1568,644
	MIA416170	M16 x 170 Ø16	25 pcs.	75 pcs.	8423533579782	1811,425
	MIA420120	M20 x 120 Ø20	20 pcs.	40 pcs.	8423533579799	2009,956
	MIA420170	M20 x 170 Ø20	20 pcs.	40 pcs.	8423533579805	2747,532
	MIA420220	M20 x 220 Ø20	20 pcs.	40 pcs.	8423533579812	3483,753

## CAJA VENTANA

	CÓDIGO	MEDIDA						
	CÓDIGO	MEDIDA	CANTIDAD	BOLSAS	EAN	CANTIDAD	EAN	PRECIO
	VMIA408075	M8 x 75 Ø8	80 pcs.	8 bolsas	8423533052933	10pcs.	8423533753830	32,115
	VMIA410090	M10 x 90 Ø10	64 pcs.	8 bolsas	8423533052940	8pcs.	8423533753847	43,953
	VMIA412110	M12 x 110 Ø12	48 pcs.	8 bolsas	8423533052957	6pcs.	8423533753854	50,288

LIBRE SERVICIO



CÓDIGO	MEDIDA	CANTIDAD	BOLSAS	EAN	CANTIDAD	EAN	PRECIO
LSMIA408075	M8 x 75 Ø8	84 pcs.	7 bolsas	8423533408235	12pcs.	8423533761958	35,439
LSMIA410090	M10 x 90 Ø10	56 pcs.	7 bolsas	8423533408228	8pcs.	8423533761989	46,268
LSMIA412110	M12 x 110 Ø12	30 pcs.	5 bolsas	8423533408211	6pcs.	8423533762016	50,367

INFORMACIÓN TÉCNICA

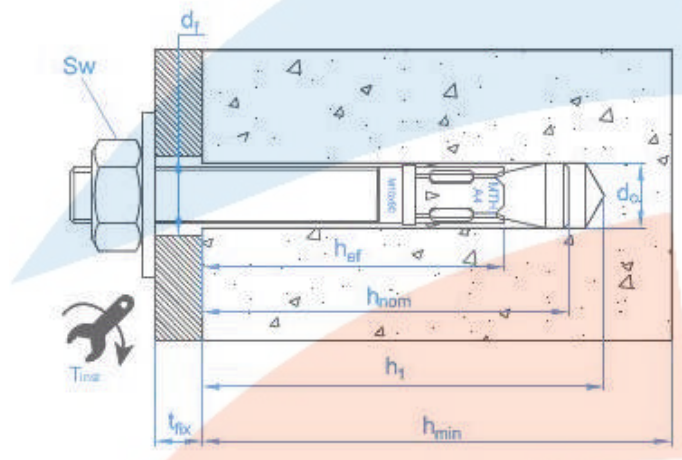

CÓDIGO	MEDIDA	Ø Broca	Ø elemento a fijar	Profundidad min. de taladro	Espesor material base	Profundidad min. del anclaje	Profundidad efectiva	Espesor máx. a fijar	Par de apriete	Distancia min. al borde	Distancia min. entre ejes	Llave de instalación	Extracción hormigón no-fisurado	Cizalladura hormigón no-fisurado
MIA406045	M6 x 45 Ø6	6	7	40	100	35	25	1	7	40	75	10	306	287
MIA406060	M6 x 60 Ø6	6	7	55	100	50	40	2	7	60	120	10	438	287
MIA406080	M6 x 80 Ø6	6	7	55	100	50	40	22	7	60	120	10	438	287
MIA408050	M8 x 50 Ø8	8	9	40	100	35	23	4	20	40	75	13	225	270
MIA408075	M8 x 75 Ø8	8	9	65	100	60	48	5	20	72	144	13	582	522
MIA408090	M8 x 90 Ø8	8	9	65	100	60	48	20	20	72	144	13	582	522
MIA408115	M8 x 115 Ø8	8	9	65	100	60	48	45	20	72	144	13	582	522
MIA410070	M10 x 70 Ø10	10	12	60	100	54	42	3	35	60	120	17	485	667
MIA410090	M10 x 90 Ø10	10	12	75	110	67	55	10	35	83	165	17	647	834
MIA410120	M10 x 120 Ø10	10	12	75	110	67	55	40	35	83	165	17	647	834
MIA410150	M10 x 150 Ø10	10	12	75	110	67	55	70	35	83	165	17	647	834
MIA412075	M12 x 75 Ø12	12	14	60	100	55	43	5	60	65	130	19	576	691
MIA412090	M12 x 90 Ø12	12	14	70	100	62	50	13	60	75	90	19	647	867
MIA412110	M12 x 110 Ø12	12	14	85	130	77	65	12	60	98	195	19	1011	1207
MIA412140	M12 x 140 Ø12	12	14	85	130	77	65	42	60	98	195	19	1011	1207

MIA416090 M16 x 90 Ø16	16	18	75	100	69	49	4	120	75	150	24	701	841
MIA416145 M16 x 145 Ø16	16	18	110	168	104	84	23	120	126	252	24	1416	2256
MIA416170 M16 x 170 Ø16	16	18	110	168	104	84	48	120	126	252	24	1416	2256
MIA420120 M20 x 120 Ø20	20	22	105	145	93	71	5	240	110	225	30	1222	2933
MIA420170 M20 x 170 Ø20	20	22	135	206	125	103	23	240	155	309	30	2023	3521
MIA420220 M20 x 220 Ø20	20	22	135	206	125	103	73	240	155	309	30	2023	3521
VMIA408075M8 x 75 Ø8	8	9	65	100	59.5	48	5	20	72	144	13	582	522
VMIA410090 M10 x 90 Ø10	10	12	75	110	66.5	55	10	35	83	165	17	647	834
VMIA412110M12 x 110 Ø12	12	14	85	130	77	65	12	60	98	195	19	1011	1207
LSMIA408075M8 x 75 Ø8	8	9	65	100	59.5	48	5	20	72	144	13	582	522
LSMIA410090M10 x 90 Ø10	10	12	75	110	66.5	55	10	35	83	165	17	647	834
LSMIA412110M12 x 110 Ø12	12	14	85	130	77	65	12	60	98	195	19	1011	1207

## CARACTERÍSTICAS



Inoxidable A4



Cargas altas



Disponibilidad con el acabado: D16, R21  
Alc. mateado con: D16, R21 y mateado  
Organizado con: Barandilla R21  
Cualquier otro color  
Así lo puedes adaptar al entorno por el color de la obra



DO-MT  
Un producto  
que se adapta  
a cualquier  
entorno

## RECOMENDADO PARA



Andamio



Antena



Banco de parque



Barandilla



Barandilla de balcón



Barandilla de  
carretera



Barandilla de madera



Barandilla de playa

## DOCUMENTACIÓN TÉCNICA



CERT\_EOTA

<https://www.indexfix.com/docs/eta-mth-mtha2-mtha4-es.PDF>