

LLAVES DE VASO 1/4"



tanto en mm como en pulgadas

- 6 y 12 cantos



EGA Master ofrece una amplia gama de llaves de vaso, tanto en serie corta como en serie larga, ofreciendo a su vez un gran número de artículos complementarios a éstos, como adaptadores, mangos articulados, alargaderas, llaves de carraca, etc.

Dispone de gamas de 1/4", 3/8", 1/2", 3/4" y 1" de cuadrado conductor en vasos manuales y de 3/8", 1/2", 3/4", 1", 1.1/2", 2.1/2" y 3.1/2" en vasos de impacto, siendo los únicos del sector con una gama tan extensa.

Fabricados en **romo-vanadio**, están diseñados para soportar altos pares de apriete con mínimo desgaste, proporcionando una mayor durabilidad.

LLAVE DE VASO

1/4"

mm

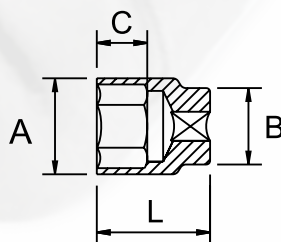

COD X	AF	L	A	B	C	PAR MÁXIMO Nm	gr.	30	25	20	1
61322	3,2mm	6			7	7,08					
61311	4mm	7			8	10,4					
63974	4,5mm				12	12	9	30			
61312	5mm	8				15,1					
63975	5,5mm	9	12			17,8					
61313	6mm				9	20,6	10				
61314	7mm	25	11			26,8					1
61315	8mm		12			33,6	12	25			
61316	9mm		13			41,1	13				
61317	10mm		15	13		49,1	15				
61318	11mm		16	14		57,8	17			20	
61319	12mm		17		13	67	20				
61320	13mm		18	15		68,6	23				
61321	14mm		17								

UNE 16501:2009 (ISO 1711-1) Cr-V DIN 3124

1/4"

mm

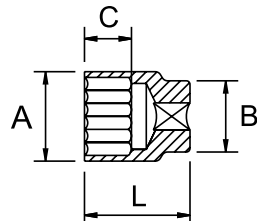

COD X	AF	L	A	B	C	PAR MÁXIMO Nm	gr.	30	25	20	1
63977	5mm	8				15,1					
63978	5,5mm	9				17,8	9	30			
63979	6mm				9	20,6	10				
63980	7mm	11	12			26,8					
63981	8mm	12				33,6	12	25			
63982	9mm	25	13			41,1	13				1
63983	10mm		15	13		49,1	15				
63984	11mm		16	14		57,8	17			20	
63985	12mm		17		13	67	20				
63986	13mm		18	15		68,6	23				
63987	14mm		17								

UNE 16501:2009 (ISO 1711-1) Cr-V DIN 3124

- x 50% cromado aeroespacial
- 50% cromado pulido espejo
- y 100% cromado pulido espejo

GARANTIA ILIMITADA

LLAVE DE VASO

1/4"
Inch.

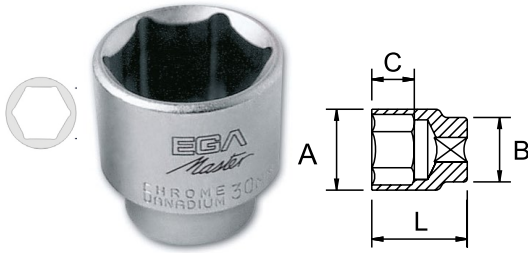

COD y	AF	L	A	B	C	PAR MÁXIMO Nm	gr.	1	
60420	5/32"		7		9	10,4	9	30	
60421	3/16"		9		12	17,8	10		
60422	7/32"		9,5		11	20,6	12		
60423	1/4"		11			26,8		25	
60424	9/32"		12			33,6	13		
60425	5/16"					41,1	15		
60426	11/32"		14	14	12	49,1	16		
60427	3/8"		16	16		57,8	21	20	
60428	7/16"		18	18		68,6	27		
60429	1/2"		20	20	13		34		
60430	9/16"								

UNE 16501:2009 (ISO 1711-1) Cr-V DIN 3124

1/4"
Inch.

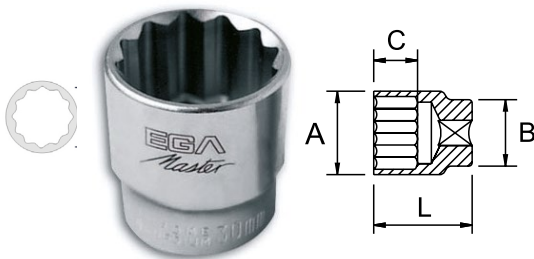

COD y	AF	L	A	B	C	PAR MÁXIMO Nm	gr.	1	
63989	3/16"		7		9	15,1	9	30	
63990	7/32"		9		12	17,8	10		
63991	1/4"		9,5		11	20,6	12		
63992	9/32"		11			26,8		25	
63993	5/16"		12			33,6	13		
63994	11/32"					41,1	15		
63995	3/8"		14	14	12	49,1	16		
63996	7/16"		16	16		57,8	21	20	
63997	1/2"		18	18		68,6	27		
63998	9/16"		20	20	13		34		

UNE 16501:2009 (ISO 1711-1) Cr-V DIN 3124

SERIE LARGA

1/4"
mm

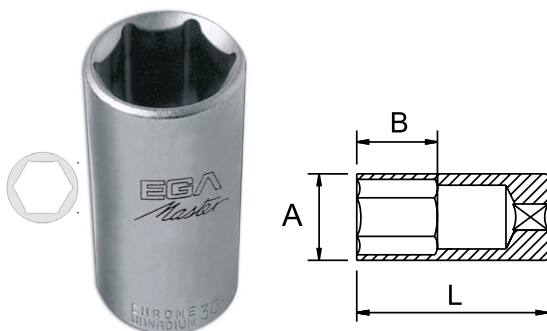

COD x	AF	L	A	B	PAR MÁXIMO Nm	gr.	1	
67640	4mm		7	10	10,4	20		
67641	4,5mm		8		12	21		
67642	5mm		9	11	15,1	23		
67643	5,5mm		9,5		17,8	24		
67644	6mm		11	14	20,6	26		
67645	7mm		12	19	26,8	27		
67646	8mm		13		33,6		10	
67647	9mm		15	20	41,1	37		
67648	10mm		16		49,1	39		
67649	11mm		17	22	57,8	46		
67650	12mm		18		67	50		
67651	13mm		18	23	68,6	55		
67652	14mm		20			75		

UNE 16501:2009 (ISO 1711-1) Cr-V DIN 3124

- x 50% cromado aeroespacial
- 50% cromado pulido espejo
- y 100% cromado pulido espejo

GARANTIA ILIMITADA

SERIE LARGA

1/4"
 mm

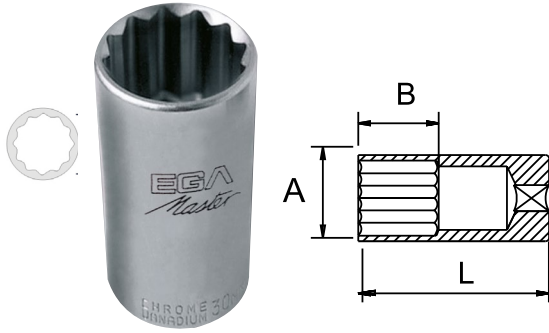

COD X	AF	L	A	B	PAR MÁXIMO Nm	gr.		
67660	5mm		8		15,1	23		
67661	5,5mm		9	11	17,8	24		
67662	6mm		9,5	14	20,6	26		
67663	7mm		11	19	26,8	27		
67664	8mm		12		33,6			
67665	9mm	50	13	20	41,1	37	10	1
67666	10mm		15		49,1	39		
67667	11mm		16	22	57,8	46		
67668	12mm		17		67	50		
67669	13mm		18	23	68,6	55		
67670	14mm		20			75		

UNE 16501:2009 (ISO 1711-1) Cr-V DIN 3124

1/4"
 Inch.

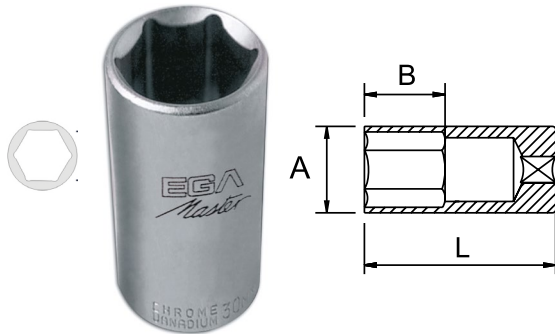

COD y	AF	L	A	B	PAR MÁXIMO Nm	gr.		
67674	5/32"		7	8	10,4	22		
67675	3/16"		8	11	15,1	24		
67676	7/32"		9	14	17,8			
67677	1/4"		9,5		20,6			
67678	9/32"		11	18	26,8	28		
67679	5/16"	50	12	20	33,6	30	10	1
67680	11/32"		13		41,1	30		
67681	3/8"				49,1	44		
67682	7/16"		16	22	57,8	45		
67683	1/2"				68,6	55		
67684	9/16"		20	26		70		

UNE 16501:2009 (ISO 1711-1) Cr-V DIN 3124

1/4"
 Inch.

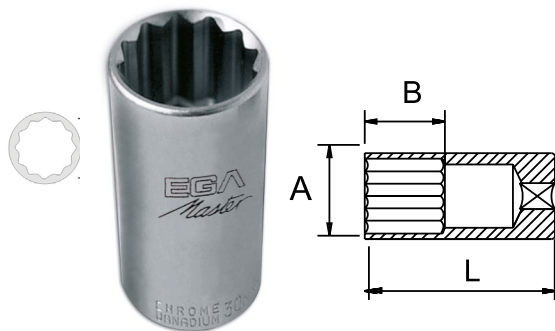

COD y	AF	L	A	B	PAR MÁXIMO Nm	gr.		
67689	5/32"		7	8	10,4	22		
67690	3/16"		8	11	15,1	24		
67691	7/32"		9	14	17,8			
67692	1/4"		9,5		20,6			
67693	9/32"		11	18	26,8	28		
67694	5/16"	50	12	20	33,6	30	10	1
67695	11/32"		13		41,1	30		
67696	3/8"				49,1	44		
67697	7/16"		16	22	57,8	45		
67698	1/2"				68,6	55		
67699	9/16"		20	26		70		

UNE 16501:2009 (ISO 1711-1) Cr-V DIN 3124

- x 50% cromado aeroespacial
- 50% cromado pulido espejo
- y 100% cromado pulido espejo

GARANTIA ILIMITADA

SPLINE

1/4"

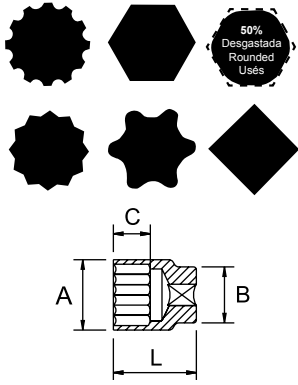

COD y	AF		E	L A B C			PAR MÁXIMO Nm	gr.	Red	Calculator	
	AF	AF		L	A	B					C
56015	M5	5/32"	4mm	E5			7	10,4			
56017	M6	-	5mm	E6			8	15,1			
56018	M7	7/32"	5,5mm	-			8,5	17,8	10	30	
56019	-	-	6mm	-			9	20,6			
55813	-	1/4"	-	-							
56020	M9	9/32"	7mm	-			10,5	26,8		25	
56021	M10	5/16"	8mm	E10	25	13	13	10	33,6	14	1
56023	-	-	10mm	-						20	
55814	-	3/8"	-	-			16	16	49,1	23	25
56024	M14	7/16	11mm	E14				57,8			
56025	M15	-	12mm	E16			18	18	67	27	20
56026	M16	1/2"	13mm	-			19	19	68,6	30	
56027	M18	-	14mm	E18			20	20		33	

UNE 16501:2009 (ISO 1711-1) Cr-V DIN 3120

EXTRACTOR DE TUERCAS DESGASTADAS HASTA EL 50%

1/4"

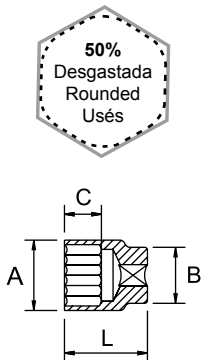

COD y	AF		E	L A B C			PAR MÁXIMO Nm	gr.	Red	Calculator	
	AF	AF		L	A	B					C
56015	4mm						7	10,4			
56017	5mm						8	15,1			
56018	5,5mm		12				8,5	17,8	10	30	
56019	6mm						9	20,6			
56020	7mm						10,5	26,8			
56021	8mm		25	13	13	10	33,6	14	25	1	
56023	10mm							49,1	23		
56024	11mm							57,8			
56025	12mm						18	18	67	27	20
56026	13mm						19	19	68,6	30	
56027	14mm						20	20		33	

UNE 16501:2009 (ISO 1711-1) Cr-V DIN 3120

- x 50% cromado aeroespacial
- 50% cromado pulido espejo
- y 100% cromado pulido espejo

GARANTIA ILIMITADA

1/4"

ADAPTADOR

Fabricado en acero al CR-V



COD	1/4"	gr.		
65880	1/4-3/8"	15	6	1

DESTORNILLADOR PORTAVASOS 1/4"



COD	1/4"	L	gr.		
66732	1/4"	190	95	6	1

DESTORNILLADOR PORTAPUNTAS MAGNÉTICO



COD	1/4"	L mm	gr.		
66731	1/4"	215	105	6	1

1.000V
IEC 60900



COD	1/4"	L mm	gr.		
76737	1/4"	210	120	6	1

PUNTA HEXAGONAL



COD	1/4"	L mm		PCS
55941	1/4"	50		5

LLAVE DE CARRACA REVERSIBLE

Fabricado en acero al CR-V

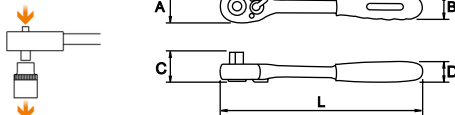

COD	1/4"	L mm	A	B	C	D	gr.		
61428	1/4"	150	28	21	21	15	105	6	1

40 Dientes DIN 3122

Fabricado en acero al CR-V

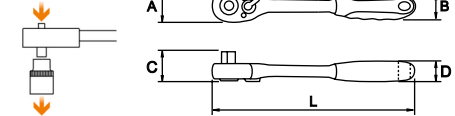

COD	1/4"	L mm	A	B	C	D	gr.		
62603	1/4"	140	23	21	22	17	105	6	1

48 Dientes DIN 3122

Fabricado en acero al CR-V

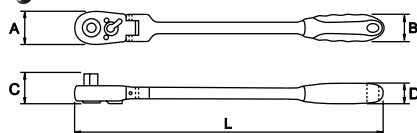

COD	1/4"	L mm	A	B	C	D	gr.		
57411	1/4"	160	22	21	23	17	120	6	1

48 Dientes DIN 3122

1/4"

LLAVE DE CARRACA REVERSIBLE

Fabricado en acero al CR-V/Cr-Mo

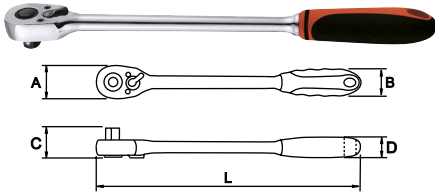

COD	1/4"	L mm	A	B	C	D	gr.		
57414	1/4"	180	23	21	21	17	150	6	1

48 Dientes DIN 3122

MANGO CORREDIZO EN "T"

Fabricado en acero al CR-V



COD	1/4"	L	gr.		
61438	1/4"	115	60	5	1

DIN 3122

ARTICULACIÓN UNIVERSAL

Fabricado en acero al CR-V



COD	1/4"	gr.			
61435	1/4"	30	10	1	

DIN 3123

ALARGADERA

Fabricado en acero al CR-V



COD	1/4"	L	gr.		
61442	1/4"	2"	25	5	1
61454		3"	35		
61443		4"	45		
61444		6"	65		
62731		10"	110		

DIN 3123

ALARGADERA FLEXIBLE

Fabricado en acero al CR-V



COD	1/4"	L	gr.		
61445	1/4"	6"	60	5	-

DIN 3122

MANGO ARTICULADO

Fabricado en acero al CR-V



COD	1/4"	L	gr.		
65874	1/4"	150	260	5	1

CARACTERÍSTICAS TÉCNICAS

MATERIAL	Cr-V
DUREZA MÍNIMA	39 HRC







GARANTIA ILIMITADA

SETS









1/4"



18pcs







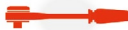

COD		Kg.
55591	4-4,5-5-5,5-6-7-8-9-10-11-12-13-14mm	0,6
	Carraca 	●
	Alargadera 	4"
	Mango en T 	●
	Articulación universal 	●
	Destornillador portavasos 	●

29pcs

COD		Kg.
61958	4-5-6-7-8-9-10-11-12-13-14mm	0,8
61961	5/32"-3/16"-7/32"-1/4"-9/32" 5/16"-11/32"-3/8"-7/16"-1/2"-9/16"	
	Carraca 	●
	Alargadera 	2"-6"
	Mango en T 	●
	Articulación universal 	●
	Punta hexagonal con vaso 	3-4-5-6-8
	Punta plana con vaso 	4x0,6 - 5,5x1 - 7x1,2
	Punta Philips con vaso 	PH1-PH2-PH3-PH4
	Destornillador portavasos 	●



29pcs

COD		Kg.
55667	M5, M6, M7, M8, M9, M10, M12, M14, M15, M16, M18	0,8
	Carraca 	●
	Alargadera 	2"-6"
	Mango en T 	●
	Articulación universal 	●
	Punta hexagonal con vaso 	3-4-5-6-8
	Punta plana con vaso 	4x0,6 - 5,5x1 - 7x1,2
	Punta Philips con vaso 	PH1-PH2-PH3-PH4
	Destornillador portavasos 	●



SETS

1/4"



30pcs

COD	AF	Kg.
55592	3,2-4-4,5-5-5,5-6-7-8-9-10-11-12mm	1,5
	5/32"-3/16"-7/32"-1/4"-9/32"-5/16"-11/32"-3/8"-7/16"-1/2"-9/16"	
Carraca		●
Alargadera		2" - 6"
Alargadera flexible		●
Mango articulado		●
Mango en T		●
Articulación universal		●
Destornillador portavasos		●

33pcs

COD	AF	Serie larga	Kg.
55590	3,2-4-5-5,5-6-7-8-9-10-11-12-13-14mm	4-5-5,5-6-7-8-9-10-11-12-13-14mm	1,5
Carraca		●	
Alargadera		2" - 6"	
Alargadera flexible		●	
Mango articulado		●	
Mango en T		●	
Articulación universal		●	
Destornillador portavasos		●	



24pcs

COD	AF	Kg.
61791	4-5-6-7-8-9-10-11-12-13mm	0,8
	3/16"-7/32"-1/4"-9/32"- 5/16"-11/32"-3/8"-7/16"-1/2"	
Carraca		●
Alargadera		2"
Articulación universal		●
Mango articulado		●
Destornillador portavasos		●





SETS

1/4"



12pcs

COD	AF <small>± C T</small>	Kg. 
61323	4-5-6-7-8-9-10-11-12-13-14mm	0,4
61324	5/32"-3/16"-7/32"-1/4"-9/32" 5/16"-11/32"-3/8"-7/16"-1/2"-9/16"	
Carraca 		

GARANTIA ILIMITADA