

LLAVES DE VASO 1/4"



tanto en mm como en pulgadas

- 6 y 12 cantos



Fabricados en **romo-vanadio**, están diseñados para soportar altos pares de apriete con mínimo desgaste, proporcionando una mayor durabilidad.

EGA Master ofrece una amplia gama de llaves de vaso, tanto en serie corta como en serie larga, ofreciendo a su vez un gran número de artículos complementarios a éstos, como adaptadores, mangos articulados, alargaderas, llaves de carraca, etc.

Dispone de gamas de 1/4", 3/8", 1/2", 3/4" y 1" de cuadrado conductor en vasos manuales y de 3/8", 1/2", 3/4", 1", 1.1/2", 2.1/2" y 3.1/2" en vasos de impacto, siendo los únicos del sector con una gama tan extensa.

LLAVE DE VASO

1/4"

mm



| COD X | AF | L | A | B | C | PAR MÁXIMO Nm | gr. | Red | Impact |
|-------|-------|----|----|----|------|---------------|-----|-----|--------|
| 61322 | 3,2mm | 6 | | | 7 | 7,08 | | | |
| 61311 | 4mm | 7 | | | 8 | 10,4 | | | |
| 63974 | 4,5mm | 7 | | | 12 | 12 | 9 | 30 | |
| 61312 | 5mm | 8 | | | 15,1 | | | | |
| 63975 | 5,5mm | 9 | 12 | | 17,8 | | | | |
| 61313 | 6mm | 9 | | | 20,6 | 10 | | | |
| 61314 | 7mm | 11 | 25 | | 26,8 | | | | |
| 61315 | 8mm | 12 | | | 33,6 | 12 | 25 | 1 | |
| 61316 | 9mm | 13 | | | 41,1 | 13 | | | |
| 61317 | 10mm | 15 | 13 | | 49,1 | 15 | | | |
| 61318 | 11mm | 16 | 14 | | 57,8 | 17 | 20 | | |
| 61319 | 12mm | 17 | | 13 | 67 | 20 | | | |
| 61320 | 13mm | 18 | 15 | | 68,6 | 23 | | | |
| 61321 | 14mm | 17 | | | | | | | |

UNE 16501:2009 (ISO 1711-1) Cr-V DIN 3124

1/4"

mm



| COD X | AF | L | A | B | C | PAR MÁXIMO Nm | gr. | Red | Impact |
|-------|-------|----|----|----|------|---------------|-----|-----|--------|
| 63977 | 5mm | 8 | | | 15,1 | | 9 | 30 | |
| 63978 | 5,5mm | 9 | | | 17,8 | | | | |
| 63979 | 6mm | 9 | | | 20,6 | 10 | | | |
| 63980 | 7mm | 11 | 12 | | 26,8 | | | | |
| 63981 | 8mm | 12 | | | 33,6 | 12 | 25 | | |
| 63982 | 9mm | 13 | 25 | | 41,1 | 13 | | | 1 |
| 63983 | 10mm | 15 | 13 | | 49,1 | 15 | | | |
| 63984 | 11mm | 16 | 14 | | 57,8 | 17 | 20 | | |
| 63985 | 12mm | 17 | | 13 | 67 | 20 | | | |
| 63986 | 13mm | 18 | 15 | | 68,6 | 23 | | | |
| 63987 | 14mm | 17 | | | | | | | |

UNE 16501:2009 (ISO 1711-1) Cr-V DIN 3124

- x 50% cromado aeroespacial
- 50% cromado pulido espejo
- y 100% cromado pulido espejo

GARANTIA ILIMITADA

LLAVE DE VASO

1/4"
Inch.



| CODy | | AF | | | PAR MÁXIMO Nm | gr. | DIN 3124 | |
|-------|--------|----|-----|----|---------------|------|----------|----|
| | | L | A | B | C | | | |
| 60420 | 5/32" | | | | 9 | 10,4 | 9 | 30 |
| 60421 | 3/16" | | 7 | | 9 | 15,1 | | |
| 60422 | 7/32" | | 9 | 12 | 11 | 17,8 | 10 | |
| 60423 | 1/4" | | 9,5 | | 11 | 20,6 | 12 | |
| 60424 | 9/32" | | 11 | | | 26,8 | | 25 |
| 60425 | 5/16" | 25 | 12 | | | 33,6 | 13 | |
| 60426 | 11/32" | | | | | 41,1 | 15 | |
| 60427 | 3/8" | | 14 | 14 | 12 | 49,1 | 16 | |
| 60428 | 7/16" | | 16 | 16 | | 57,8 | 21 | 20 |
| 60429 | 1/2" | | 18 | 18 | | 68,6 | 27 | |
| 60430 | 9/16" | | 20 | 20 | 13 | | 34 | |

UNE 16501:2009 (ISO 1711-1) Cr-V DIN 3124

1/4"
Inch.

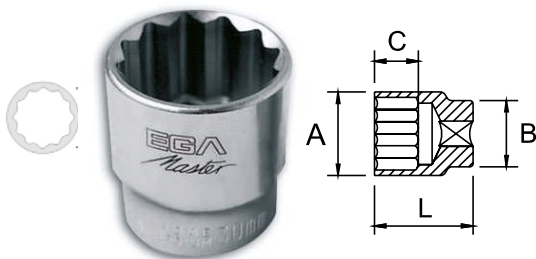

| CODy | | AF | | | PAR MÁXIMO Nm | gr. | DIN 3124 | |
|-------|--------|----|-----|----|---------------|------|----------|----|
| | | L | A | B | C | | | |
| 63989 | 3/16" | | 7 | | 9 | 15,1 | 9 | 30 |
| 63990 | 7/32" | | 9 | | | 17,8 | 10 | |
| 63991 | 1/4" | | 9,5 | 12 | 11 | 20,6 | 12 | |
| 63992 | 9/32" | | 11 | | | 26,8 | | 25 |
| 63993 | 5/16" | 25 | 12 | | | 33,6 | 13 | |
| 63994 | 11/32" | | | | | 41,1 | 15 | |
| 63995 | 3/8" | | 14 | 14 | 12 | 49,1 | 16 | |
| 63996 | 7/16" | | 16 | 16 | | 57,8 | 21 | 20 |
| 63997 | 1/2" | | 18 | 18 | | 68,6 | 27 | |
| 63998 | 9/16" | | 20 | 20 | 13 | | 34 | |

UNE 16501:2009 (ISO 1711-1) Cr-V DIN 3124

SERIE LARGA

1/4"
mm

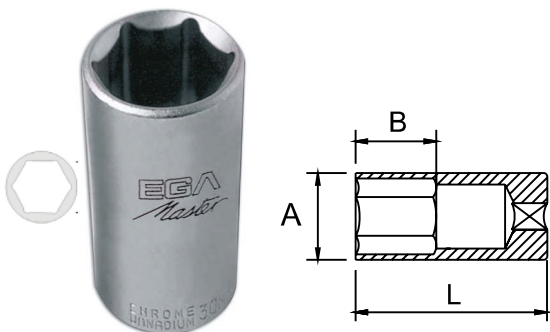

| CODx | | AF | | | PAR MÁXIMO Nm | gr. | DIN 3124 | |
|-------|-------|----|-----|----|---------------|-----|----------|---|
| | | L | A | B | | | | |
| 67640 | 4mm | | 7 | 10 | 10,4 | 20 | | |
| 67641 | 4,5mm | | 8 | | 12 | 21 | | |
| 67642 | 5mm | | | 11 | 15,1 | 23 | | |
| 67643 | 5,5mm | | 9 | | 17,8 | 24 | | |
| 67644 | 6mm | | 9,5 | 14 | 20,6 | 26 | | |
| 67645 | 7mm | | 11 | 19 | 26,8 | 27 | | |
| 67646 | 8mm | 50 | 12 | | 33,6 | | 10 | 1 |
| 67647 | 9mm | | 13 | 20 | 41,1 | 37 | | |
| 67648 | 10mm | | 15 | | 49,1 | 39 | | |
| 67649 | 11mm | | 16 | 22 | 57,8 | 46 | | |
| 67650 | 12mm | | 17 | | 67 | 50 | | |
| 67651 | 13mm | | 18 | 23 | 68,6 | 55 | | |
| 67652 | 14mm | | 20 | | | 75 | | |

UNE 16501:2009 (ISO 1711-1) Cr-V DIN 3124

- x 50% cromado aeroespacial
- 50% cromado pulido espejo
- y 100% cromado pulido espejo

GARANTIA ILIMITADA

SERIE LARGA

1/4"
mm

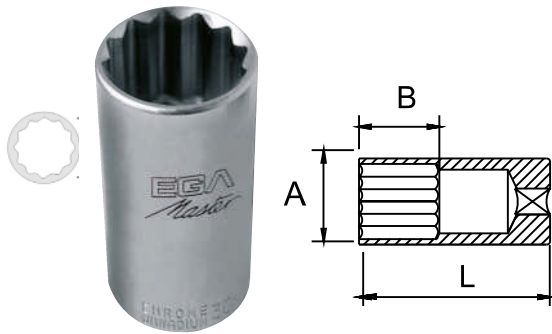

| COD X | AF | L | A | B | PAR MÁXIMO Nm | gr. | | |
|-------|-------|----|-----|----|---------------|-----|----|---|
| 67660 | 5mm | | 8 | | 15,1 | 23 | | |
| 67661 | 5,5mm | | 9 | 11 | 17,8 | 24 | | |
| 67662 | 6mm | | 9,5 | 14 | 20,6 | 26 | | |
| 67663 | 7mm | | 11 | 19 | 26,8 | 27 | | |
| 67664 | 8mm | | 12 | | 33,6 | | | |
| 67665 | 9mm | 50 | 13 | 20 | 41,1 | 37 | 10 | 1 |
| 67666 | 10mm | | 15 | | 49,1 | 39 | | |
| 67667 | 11mm | | 16 | 22 | 57,8 | 46 | | |
| 67668 | 12mm | | 17 | | 67 | 50 | | |
| 67669 | 13mm | | 18 | 23 | 68,6 | 55 | | |
| 67670 | 14mm | | 20 | | | 75 | | |

UNE 16501:2009 (ISO 1711-1) Cr-V DIN 3124

1/4"
Inch.

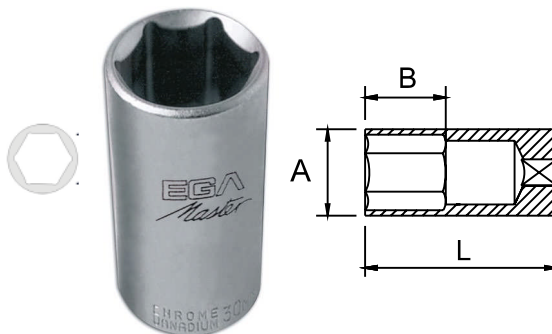

| COD Y | AF | L | A | B | PAR MÁXIMO Nm | gr. | | |
|-------|--------|----|-----|----|---------------|-----|----|---|
| 67674 | 5/32" | | 7 | 8 | 10,4 | 22 | | |
| 67675 | 3/16" | | 8 | 11 | 15,1 | 24 | | |
| 67676 | 7/32" | | 9 | 14 | 17,8 | | | |
| 67677 | 1/4" | | 9,5 | | 20,6 | | | |
| 67678 | 9/32" | | 11 | 18 | 26,8 | 28 | | |
| 67679 | 5/16" | 50 | 12 | 20 | 33,6 | | 10 | 1 |
| 67680 | 11/32" | | 13 | | 41,1 | 30 | | |
| 67681 | 3/8" | | | | 49,1 | 44 | | |
| 67682 | 7/16" | | 16 | 22 | 57,8 | 45 | | |
| 67683 | 1/2" | | | | 68,6 | 55 | | |
| 67684 | 9/16" | | 20 | 26 | | 70 | | |

UNE 16501:2009 (ISO 1711-1) Cr-V DIN 3124

1/4"
Inch.

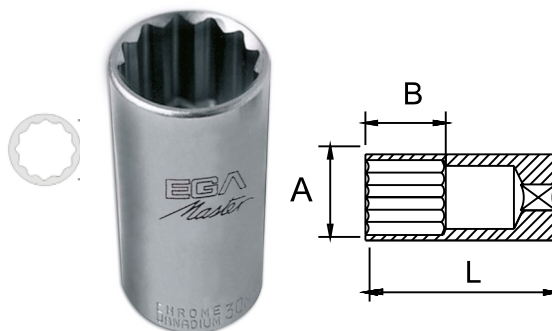

| COD y | AF | L | A | B | PAR MÁXIMO Nm | gr. | | |
|-------|--------|----|-----|----|---------------|-----|----|---|
| 67689 | 5/32" | | 7 | 8 | 10,4 | 22 | | |
| 67690 | 3/16" | | 8 | 11 | 15,1 | 24 | | |
| 67691 | 7/32" | | 9 | 14 | 17,8 | | | |
| 67692 | 1/4" | | 9,5 | | 20,6 | | | |
| 67693 | 9/32" | | 11 | 18 | 26,8 | 28 | | |
| 67694 | 5/16" | 50 | 12 | 20 | 33,6 | | 10 | 1 |
| 67695 | 11/32" | | 13 | | 41,1 | 30 | | |
| 67696 | 3/8" | | | | 49,1 | 44 | | |
| 67697 | 7/16" | | 16 | 22 | 57,8 | 45 | | |
| 67698 | 1/2" | | | | 68,6 | 55 | | |
| 67699 | 9/16" | | 20 | 26 | | 70 | | |

UNE 16501:2009 (ISO 1711-1) Cr-V DIN 3124

- x 50% cromado aeroespacial
- 50% cromado pulido espejo
- y 100% cromado pulido espejo

GARANTIA ILIMITADA

SPLINE

1/4"

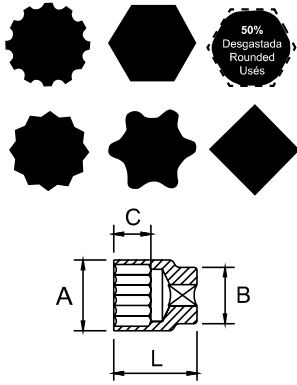

| COD y | AF | AF | TX | L | A | B | C | PAR MÁXIMO Nm | gr | 1 | |
|-------|-----|-------|-------|-----|----|----|------|---------------|------|----|----|
| 56015 | M5 | 5/32" | 4mm | E5 | | | 7 | 10,4 | | | |
| 56017 | M6 | - | 5mm | E6 | | | 8 | 15,1 | | | |
| 56018 | M7 | 7/32" | 5,5mm | - | 12 | | 8,5 | 17,8 | 10 | 30 | |
| 56019 | - | - | 6mm | - | | | 9 | 20,6 | | | |
| 55813 | - | 1/4" | - | - | | | | | | | |
| 56020 | M9 | 9/32" | 7mm | - | | | 10,5 | 26,8 | | 25 | |
| 56021 | M10 | 5/16" | 8mm | E10 | 25 | 13 | 13 | 10 | 33,6 | 14 | 1 |
| 56023 | - | - | 10mm | - | | | | | 49,1 | 23 | 20 |
| 55814 | - | 3/8" | - | - | 16 | 16 | | | | | 25 |
| 56024 | M14 | 7/16 | 11mm | E14 | | | | | 57,8 | | |
| 56025 | M15 | - | 12mm | E16 | | | 18 | 18 | 67 | 27 | 20 |
| 56026 | M16 | 1/2" | 13mm | - | | | 19 | 19 | | 30 | |
| 56027 | M18 | - | 14mm | E18 | | | 20 | 20 | 68,6 | 33 | |

UNE 16501:2009 (ISO 1711-1) Cr-V DIN 3120

EXTRACTOR DE TUERCAS DESGASTADAS HASTA EL 50%

1/4"

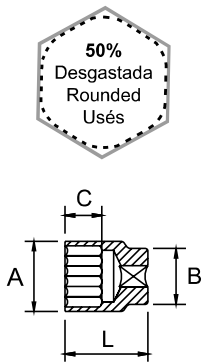

| COD y | AF | L | A | B | C | PAR MÁXIMO Nm | gr | 1 | |
|-------|-------|----|----|----|------|---------------|----|----|---|
| 56015 | 4mm | | | | 7 | 10,4 | | | |
| 56017 | 5mm | | | | 8 | 15,1 | | | |
| 56018 | 5,5mm | 12 | | | 8,5 | 17,8 | 10 | 30 | |
| 56019 | 6mm | | | | 9 | 20,6 | | | |
| 56020 | 7mm | | | | 10,5 | 26,8 | | | |
| 56021 | 8mm | 25 | 13 | 13 | 10 | 33,6 | 14 | 25 | 1 |
| 56023 | 10mm | | | | | 49,1 | 23 | | |
| 56024 | 11mm | | 16 | 16 | | 57,8 | | | |
| 56025 | 12mm | | 18 | 18 | | 67 | 27 | 20 | |
| 56026 | 13mm | | 19 | 19 | | | 30 | | |
| 56027 | 14mm | | 20 | 20 | | 68,6 | 33 | | |

UNE 16501:2009 (ISO 1711-1) Cr-V DIN 3120

- x 50% cromado aeroespacial
- 50% cromado pulido espejo
- y 100% cromado pulido espejo

GARANTIA ILIMITADA

1/4"

ADAPTADOR

Fabricado en acero al CR-V



| COD | 1/4" | gr. | | |
|-------|----------|-----|---|---|
| 65880 | 1/4-3/8" | 15 | 6 | 1 |

DESTORNILLADOR PORTAVASOS 1/4"



| COD | 1/4" | L mm | gr. | | |
|-------|------|------|-----|---|---|
| 66732 | 1/4" | 190 | 95 | 6 | 1 |

DESTORNILLADOR PORTAPUNTAS MAGNÉTICO



| COD | 1/4" | L mm | gr. | | |
|-------|------|------|-----|---|---|
| 66731 | 1/4" | 215 | 105 | 6 | 1 |

1.000V
IEC 60900



| COD | 1/4" | L mm | gr. | | |
|-------|------|------|-----|---|---|
| 76737 | 1/4" | 210 | 120 | 6 | 1 |

PUNTA HEXAGONAL



| COD | 1/4" | L mm | | PCS |
|-------|------|------|--|-----|
| 55941 | 1/4" | 50 | | 5 |

LLAVE DE CARRACA REVERSIBLE

Fabricado en acero al CR-V

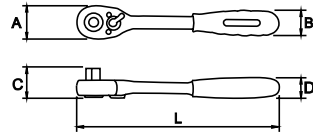
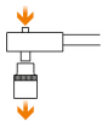

| COD | 1/4" | L mm | A | B | C | D | gr. | | |
|-------|------|------|----|----|----|----|-----|---|---|
| 61428 | 1/4" | 150 | 28 | 21 | 21 | 15 | 105 | 6 | 1 |

40 Dientes

DIN 3122

Fabricado en acero al CR-V

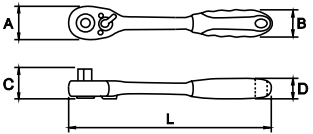
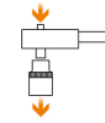

| COD | 1/4" | L mm | A | B | C | D | gr. | | |
|-------|------|------|----|----|----|----|-----|---|---|
| 62603 | 1/4" | 140 | 23 | 21 | 22 | 17 | 105 | 6 | 1 |

48 Dientes

DIN 3122

Fabricado en acero al CR-V

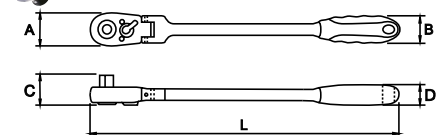

| COD | 1/4" | L mm | A | B | C | D | gr. | | |
|-------|------|------|----|----|----|----|-----|---|---|
| 57411 | 1/4" | 160 | 22 | 21 | 23 | 17 | 120 | 6 | 1 |

48 Dientes

DIN 3122

GARANTIA ILIMITADA

1/4"

LLAVE DE CARRACA REVERSIBLE

Fabricado en acero al CR-V/Cr-Mo

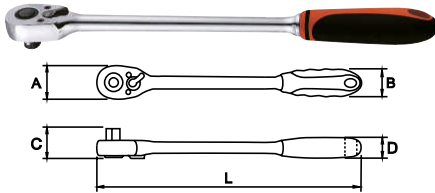

| COD | 1/4" | L mm | A | B | C | D | gr. | | |
|-------|------|------|----|----|----|----|-----|---|---|
| 57414 | 1/4" | 180 | 23 | 21 | 21 | 17 | 150 | 6 | 1 |

48 Dientes DIN 3122

MANGO CORREDIZO EN "T"

Fabricado en acero al CR-V



| COD | 1/4" | L | gr. | | |
|-------|------|-----|-----|---|---|
| 61438 | 1/4" | 115 | 60 | 5 | 1 |

DIN 3122

ARTICULACIÓN UNIVERSAL

Fabricado en acero al CR-V



| COD | 1/4" | gr. | | |
|-------|------|-----|----|---|
| 61435 | 1/4" | 30 | 10 | 1 |

DIN 3123

ALARGADERA

Fabricado en acero al CR-V



| COD | 1/4" | L | gr. | | |
|-------|------|-----|-----|---|---|
| 61442 | 1/4" | 2" | 25 | 5 | 1 |
| 61454 | | 3" | 35 | | |
| 61443 | | 4" | 45 | | |
| 61444 | | 6" | 65 | | |
| 62731 | | 10" | 110 | | |

DIN 3123

ALARGADERA FLEXIBLE

Fabricado en acero al CR-V



| COD | 1/4" | L | gr. | | |
|-------|------|----|-----|---|---|
| 61445 | 1/4" | 6" | 60 | 5 | - |

DIN 3122

MANGO ARTICULADO

Fabricado en acero al CR-V



| COD | 1/4" | L | gr. | | |
|-------|------|-----|-----|---|---|
| 65874 | 1/4" | 150 | 260 | 5 | 1 |

CARACTERÍSTICAS TÉCNICAS

| | |
|---------------|--------|
| MATERIAL | Cr-V |
| DUREZA MÍNIMA | 39 HRC |





GARANTIA ILIMITADA

SETS









1/4"



18pcs









| COD | | Kg. |
|-------|---|-----|
| 55591 | 4-4,5-5-5,5-6-7-8-9-10-11-12-13-14mm | 0,6 |
| | Carraca  | ● |
| | Alargadera  | 4" |
| | Mango en T  | ● |
| | Articulación universal  | ● |
| | Destornillador portavasos  | ● |

29pcs

| COD | | Kg. |
|-------|---|-----------------------|
| 61958 | 4-5-6-7-8-9-10-11-12-13-14mm | 0,8 |
| 61961 | 5/32"-3/16"-7/32"-1/4"-9/32" 5/16"-11/32"-3/8"-7/16"-1/2"-9/16" | |
| | Carraca  | ● |
| | Alargadera  | 2"-6" |
| | Mango en T  | ● |
| | Articulación universal  | ● |
| | Punta hexagonal con vaso  | 3-4-5-6-8 |
| | Punta plana con vaso  | 4x0,6 - 5,5x1 - 7x1,2 |
| | Punta Philips con vaso  | PH1-PH2-PH3-PH4 |
| | Destornillador portavasos  | ● |



29pcs

| COD | | Kg. |
|-------|---|-----------------------|
| 55667 | M5, M6, M7, M8, M9, M10, M12, M14, M15, M16, M18 | 0,8 |
| | Carraca  | ● |
| | Alargadera  | 2"-6" |
| | Mango en T  | ● |
| | Articulación universal  | ● |
| | Punta hexagonal con vaso  | 3-4-5-6-8 |
| | Punta plana con vaso  | 4x0,6 - 5,5x1 - 7x1,2 |
| | Punta Philips con vaso  | PH1-PH2-PH3-PH4 |
| | Destornillador portavasos  | ● |



SETS

1/4"



30pcs

| COD | AF C T | Kg. |
|---------------------------|---|---------|
| 55592 | 3,2-4-4,5-5-5,5-6-7-8-9-10-11-12mm | 1,5 |
| | 5/32"-3/16"-7/32"-1/4"-9/32"-5/16"-11/32"-3/8"-7/16"-1/2"-9/16" | |
| Carraca | | ● |
| Alargadera | | 2" - 6" |
| Alargadera flexible | | ● |
| Mango articulado | | ● |
| Mango en T | | ● |
| Articulación universal | | ● |
| Destornillador portavasos | | ● |

33pcs



| COD | C T | Serie larga C T | Kg. |
|---------------------------|--------------------------------------|----------------------------------|-----|
| 55590 | 3,2-4-5-5,5-6-7-8-9-10-11-12-13-14mm | 4-5-5,5-6-7-8-9-10-11-12-13-14mm | 1,5 |
| | | | |
| Carraca | | ● | |
| Alargadera | | 2" - 6" | |
| Alargadera flexible | | ● | |
| Mango articulado | | ● | |
| Mango en T | | ● | |
| Articulación universal | | ● | |
| Destornillador portavasos | | ● | |

24pcs



| COD | AF C T | Kg. |
|---------------------------|---|-----|
| 61791 | 4-5-6-7-8-9-10-11-12-13mm | 0,8 |
| | 3/16"-7/32"-1/4"-9/32"-5/16"-11/32"-3/8"-7/16"-1/2" | |
| Carraca | | ● |
| Alargadera | | 2" |
| Articulación universal | | ● |
| Mango articulado | | ● |
| Destornillador portavasos | | ● |

SETS

1/4"



12pcs

| COD | AF ┌ C └ | Kg. |
|------------|--|------------|
| 61323 | 4-5-6-7-8-9-10-11-12-13-14mm | 0,4 |
| 61324 | 5/32"-3/16"-7/32"-1/4"-9/32" 5/16"-11/32"-3/8"-7/16"-1/2"-9/16" | |
| Carraca | | |

GARANTIA ILIMITADA