

LLAVES DE VASO DE IMPACTO

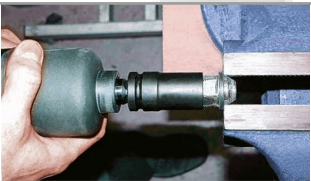

EGA Master ofrece una amplia gama de llaves de vaso de impacto, serie corta, serie larga, adaptador, articulación universal, alargadera, anilla de seguridad, pasador de seguridad...etc.

Fabricados en **acero cromo-molibdeno** o en **cromo-vanadio**, están diseñados para soportar altos pares de apriete con mínimo desgaste, proporcionando una mayor durabilidad.



Diseño cilíndrico en todas las medidas para aportar una **mayor accesibilidad**.

LLAVES DE VASO DE IMPACTO

3/8"



MM

COD	AF	L	A	B	C	gr.	Red	Box
60590	7mm		12			41		
60591	8mm		13					
60592	9mm		14	19	14	43		
60593	10mm		16					
60594	11mm		17			44		
60595	12mm		18					
60596	13mm	30	20	20	15		6	1
60597	14mm		21	21				
60598	15mm		22	22		60		
60599	16mm		23	23	16			
60600	17mm		24	24				
60601	18mm		26	26				
60602	19mm		27	27		70		

Cr-V DIN 3129

INCH.





COD	AF	L	A	B	C	gr.	Red	Box
65205	5/16"		13			43		
65206	3/8"		15					
65207	7/16"		17	19	14	44		
65208	1/2"		19		15			
65209	9/16"		21	21				
65210	5/8"	30	23	23		60	6	1
65211	11/16"		25	25	16			
65212	3/4"		27	27		70		
68685	13/16"		30	30		100		
68686	7/8"		32	32		125		

Cr-V DIN 3129

PUNTAS ATORNILLADORAS DE IMPACTO CON VASO





3/8"

HEXAGONAL

COD					
65920	3	78	45	10	1
65921	4		50		
65922	5		55		
65923	6		65		
65924	8		85		
65925	10		100		
65926	12		120		
65927	14				



TORX

COD					
65928	T25	60	40	10	1
65929	T27		45		
65930	T30		50		
65931	T40		55		
65932	T45		65		
65933	T50		75		
65934	T55				
65935	T60				





LLAVES DE VASO DE IMPACTO

1/2"

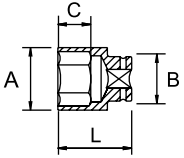

MM

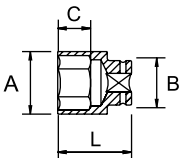

COD	AF	L	A	B	C	gr.		
60658	8mm							
57987	9mm	17				65		
60603	10mm							
60604	11mm	19		15				
60605	12mm	20	24					
60606	13mm	22				80		
60607	14mm							
60608	15mm	24						
60609	16mm			16		95		
60610	17mm	26	26					
60611	18mm	28	28			110		
60612	19mm							
60639	20mm	29	29	18			6	1
60613	21mm	30	30			120		
60614	22mm	32	32			140		
58450	23mm	34	34			160		
60615	24mm			20				
58451	25mm	36	36			190		
60616	27mm	38				185		
57988	28mm	40	35			188		
60617	29mm					200		
60618	30mm	43	42	20		210		
60619	32mm	38	44	35				
57989	33mm	48	47	30	23	236		
57990	34mm					248		
60712	36mm	50	50	36	23	350		

INCH.



COD	AF	L	A	B	C	gr.		
65213	3/8"	16						
65214	7/16"	18						
65215	1/2"	20	23	14		85		
65216	9/16"	22						
65217	5/8"	24	24	15				
65218	11/16"	26	26			125		
65219	3/4"	28	28	16				
65220	13/16"	30	30	19			6	1
65221	7/8"	32	32	20		130		
65222	15/16"	34	34			135		
65223	1"	36				145		
65224	1.1/16"	38				170		
65225	1.1/8"	40	35	21		190		
57985	1.3/16"	42				200		
65226	1.1/4"	44						

Cr-V DIN 3129

Cr-V DIN 3129

SERIE LARGA

1/2"

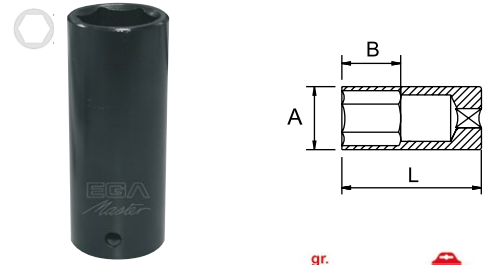

MM	COD	AF	L	A	B	gr.		
57994	9mm		16	24	142			
60660	10mm		17					
60661	11mm		18	27				
60662	12mm		19					
60663	13mm		20					
60664	14mm		22	37	190			
58452	15mm		24	34				
60665	16mm		26					
60666	17mm		27					
60667	18mm		28					
60668	19mm	80	30			260	6	1
57995	20mm		31					
60669	21mm		32	37	310			
60670	22mm		33		320			
60671	23mm		34		340			
60672	24mm		38		400			
60673	27mm		40		420			
60674	29mm		42		430			
60675	30mm		44		450			
60676	32mm		47	38	503			

INCH.	COD	AF	L	A	B	gr.		
55630	3/8"		18	24				
55631	7/16"		20					
55632	1/2"		22	29	190			
55633	9/16"		24					
55634	5/8"		26					
55635	11/16"		28			220		
55636	3/4"		30			250	6	1
55637	13/16"	80	32			290		
55638	7/8"		34	36	320			
55639	15/16"		36			370		
55640	1"		38			420		
55641	1.1/16"		40			386		
55642	1.1/8"		42			420		
57992	1.3/16"		44					
55643	1.1/4"							

Cr-V DIN 3129

Cr-V DIN 3129

PUNTAS ATORNILLADORAS DE IMPACTO CON VASO

1/2"

HEXAGONAL

COD		L mm	gr.		
65936	4		80		
65937	5		85		
65938	6		95		
65939	8		110		
65940	10	78	120	10	1
65941	11		125		
65942	12		140		
65943	14		170		
65944	17		200		
65945	19				



TORX

COD		L mm	gr.		
65946	T25		75		
65947	T27		80		
65948	T30		85		
65949	T40	78	90	10	1
65950	T45		110		
65951	T50		120		
65952	T55				
65953	T60				



LLAVES DE VASO DE IMPACTO

3/4"



MM							INCH.						
COD	AF	L	A	B	C	gr.	COD	AF	L	A	B	C	gr.
63879	17mm		30			220	57353	11/16"		29	38	16	220
60620	19mm		33				65227	3/4"		33			
57335	20mm		35		18		65228	13/16"	50	35		18	
60621	21mm		37				65229	7/8"		37			230
60622	22mm	50	37	38			65230	15/16"		39			
60623	23mm		38			230	65231	1"		41		22	
60624	24mm		39		22		65232	1.1/16"		43		26	
57336	25mm		40		23		65233	1.1/8"		45			310
60625	26mm		41		24		65234	1.3/16"		46			420
60626	27mm		43		26		65235	1.1/4"	55	49			440
60627	28mm		44	40			65236	1.5/16"		50	44		460
60628	29mm		45	42		310	65237	1.3/8"		55		27	480
60629	30mm		46			420	65238	1.7/16"		55			500
57337	31mm		46			430	65239	1.1/2"		60			550
60630	32mm		49			440	68689	1.9/16"		58			600
60631	33mm		49			440	65240	1.5/8"	60	60			600
60632	34mm	55	50			480	65241	1.11/16"		65			700
58454	35mm		51		27	460	65242	1.3/4"		70			750
60633	36mm		51			500	57344	1.13/16"		65			
60634	38mm		55			550	65243	1.7/8"	65	70			750
57338	39mm		55			560	57346	1.15/16"		70			
57339	40mm		55	44		570	65244	2"		70		28	
60635	41mm		60			600	57347	2.1/16"	70	75			1100
60636	42mm		60			700	57354	2.3/32"		75			1
58455	43mm		61			610	57348	2.1/8"		55			
57340	44mm	60	60			610	68688	2.3/16"	75	80			1350
57341	45mm		60			700	57999	2.1/4"		80	35	1444	
60637	46mm	65	65			700							
57342	47mm		65		28								
63880	48mm		65										
60638	50mm	70	70			1100							
57345	51mm		70										
63881	54mm		55		32								
63891	55mm	75	75			1250							
63921	60mm		85		43	1300							

Cr-Mo DIN 3129

Cr-Mo DIN 3129



SERIE LARGA

3/4"

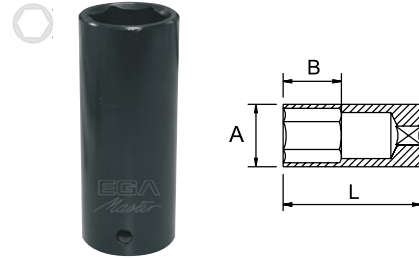
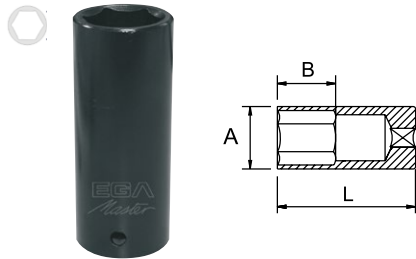

MM

COD	AF	L	A	B	gr.		
60679	19mm		33				
57349	20mm		34				
60680	21mm		35		600		
60681	22mm		37	28			
57350	23mm		39				
60682	24mm		40				
57351	25mm		41	36			
60683	26mm		42		650		
60684	27mm		44	50			
57352	28mm		45				
57353	29mm		46	55	850	1	1
60685	30mm	90	49				
60686	32mm		50		900		
60687	33mm		55	60	950		
60688	34mm		60				
60689	36mm		61	44	940		
60690	38mm		65	60	1000		
60691	41mm		65	65	1100		
63895	42mm		70	70	1200		
58456	43mm						
63945	44mm						
63896	48mm						
63897	50mm						

Cr-Mo DIN 3129

INCH.

COD	AF	L	A	B	gr.		
58001	3/4"		33				
58002	13/16"		35		550		
58003	7/8"		37	26	600		
58004	15/16"		38				
58006	1.5/8"		61	65	940		
65245	1"		38	26	550		
65246	1.1/16"		40		600		1
65247	1.1/8"		42				
65248	1.3/16"		44	28	650		
65249	1.1/4"		46		700		
65250	1.5/16"		48				
65251	1.3/8"		50	30	750		
57360	1.7/16"	90	55	34	800	1	
65252	1.1/2"		61	54	940		
58005	1.9/16"		60	34	1000		
57361	1.9/16"		65	42	1100		
57362	1.5/8"		61	65	940		
57363	1.11/16"		65	42			
58006	1.5/8"		61	65	940		
63946	1.3/4"		65	42	1000		
57364	1.13/16"		70	65	1150		
57365	1.7/8"						
57366	1.15/16"						
57367	2"						

Cr-Mo DIN 3129



LLAVES DE VASO DE IMPACTO

1"



MM

COD	AF	L	A	B	C	gr.	Icon
57372	20mm		37				
57373	21mm		38				
57374	22mm		39			500	
57375	23mm	60	40				
65534	24mm		42	50			
57376	25mm		44		23		
57377	26mm		44				
65535	27mm		45			550	
57378	28mm		46				
57379	29mm		48				
65536	30mm		49				
57380	31mm		50			600	1
65537	32mm		50				
57140	33mm		53		26	650	
57141	34mm	65	53				
57142	35mm		55			700	
65538	36mm		55				
57381	37mm		60			800	
60640	38mm		60				
57382	39mm		60				
63882	40mm		65		28	850	1
60641	41mm		65				
60642	42mm	70	65			900	
57383	44mm		65			950	
57384	45mm		55				
60643	46mm		75			1050	
57385	47mm	75	75		32		
63890	48mm		75			1100	
60644	50mm		80			1150	
60645	52mm	80	80			1200	
60646	54mm		80		45	1250	
60647	55mm		80			1300	
60648	56mm	85	85			1350	
60649	57mm		85			1450	
60650	58mm		90		47		
60651	60mm		90			1550	
60652	62mm	90	90			1700	
60653	63mm		95			1700	
60654	65mm	95	95			3600	
60655	70mm		100		50		
60656	75mm	100	105			3700	
63925	80mm		110	85	55		

Cr-Mo DIN 3129

INCH.

COD	AF	L	A	B	C	gr.	Icon
58008	3/4"		34				
58009	13/16"		36				
58010	7/8"	58	40		54	17	504
58011	15/16"		42			18	529
65253	1"		44				544
65254	1.1/16"		46				561
65255	1.1/8"		48				
65256	1.3/16"	60	49				
65257	1.1/4"		50			26	550
65258	1.5/16"		55				600
57143	1.11/32"		55			27	650
65259	1.3/8"		55				700
65260	1.7/16"		60				
65261	1.1/2"	65	60				750
65262	1.9/16"		60				800
65263	1.5/8"		65			28	850
65264	1.11/16"	70	65				
65265	1.3/4"		70				900
65266	1.13/16"		70	55			950
65267	1.7/8"	75	70				1000
68690	1.15/16"		75			32	1100
65268	2"		75				
68691	2.1/16"	80	80				1400
65269	2.1/8"		80				
65270	2.1/4"	85	85				1700
68692	2.5/16"		85				
65271	2.3/8"	90	90			47	2000
68693	2.7/16"		90				
65272	2.1/2"	95	90				2200
68694	2.9/16"		95				
65273	2.5/8"		95				2256
58012	2.11/16"		97				2560
58013	2.3/4"		99				3237
58014	2.13/16"	100	101		53		3392
58015	2.7/8"		103				3486
58016	2.15/16"		104	86			

Cr-Mo DIN 3129



SERIE LARGA

1"

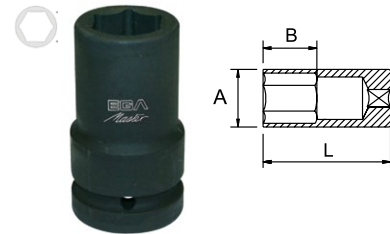
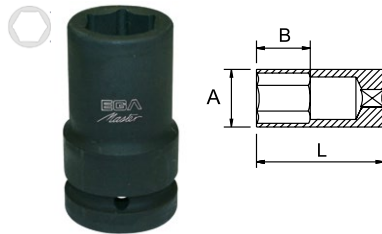

MM

COD	AF	L	A	B	gr.		
57386	20mm				700		
57387	21mm		40		750		
63898	22mm			16			
63899	23mm		41				
65539	24mm		42		800		
57388	25mm		43				
63900	26mm		44		900		
65540	27mm		46				
63905	28mm		47	19	950		
63901	29mm		48				
65541	30mm	90	49				
65542	32mm		50				
63902	33mm				1000		
63903	34mm		55			1	1
63904	35mm			23			
65543	36mm				1050		
65544	38mm		60		1100		
57392	40mm						
63883	41mm				1200		
63906	42mm						
63907	43mm		65	40	1300		
65546	46mm		70		1500		
57393	47mm	100					
65547	50mm		75		1600		
63908	55mm		80		1900		
63909	60mm	120	90	50	2500		

Cr-Mo DIN 3129

INCH.

COD	AF	L	A	B	gr.		
58018	3/4				792		
58019	13/16				822		
58020	7/8			19	854		
58021	15/16				879		
57398	1"				800		
57399	1.1/16"			30	850		
65274	1.1/8"						
65275	1.3/16"			30	1200		
65276	1.1/4"						
65277	1.5/16"						
65278	1.3/8"			35	1250		
65279	1.7/16"				1300		
65280	1.1/2"				1350		
65281	1.9/16"			60	1400	1	1
65282	1.5/8"				1450		
65283	1.11/16"	110		65	1550		
65284	1.3/4"				1600		
65285	1.13/16"			42	1650		
65286	1.7/8"				1700		
57400	1.15/16"						
65287	2"				1800		
58022	2.1/16"				1745		
58023	2.1/8"			57	1787		
58024	2.3/16"				1913		
58025	2.1/4"				2066		
58026	2.5/16"	120		86	2176		
58027	2.3/8"			58	2393		

Cr-Mo DIN 3129



LLAVES DE VASO DE IMPACTO

1.1/2"



MM

INCH

COD	AF	L	A	B	C	Kg.	
63884	34mm						
65666	35mm						
65737	36mm						
63885	38mm						
63886	40mm						
63887	41mm						
63888	42mm						
63889	43mm						
65426	46mm						
65427	50mm						
65428	55mm						
65429	60mm						
65430	65mm						
65431	70mm						
65432	75mm						
68697	77mm						
65433	80mm						
65434	85mm						
65435	90mm						
65436	95mm						
65437	100mm						
65438	105mm						
65439	110mm						
65440	115mm						
65441	120mm						
65442	125mm						
65443	130mm						
65444	135mm						
65445	140mm						
65446	145mm						
65447	150mm						

COD	AF	L	A	B	C	Kg.		
58029	1.5/16"							
68700	1.3/8"							
68701	1.7/16"							
68702	1.1/2"							
68703	1.9/16"							
68704	1.5/8"							
68705	1.11/16"							
68706	1.3/4"							
68707	1.13/16"							
68708	1.7/8"							
68709	1.15/16"							
68710	2"							
68711	2.1/16"							
68712	2.1/8"							
68713	2.3/16"							
68714	2.1/4"							
68715	2.5/16"							
68716	2.3/8"							
68717	2.7/16"							
68718	2.1/2"							
68719	2.9/16"							
68720	2.5/8"							
68721	2.11/16"							
68722	2.3/4"							
68723	2.13/16"							
68724	2.7/8"							
68725	2.15/16"							
68726	3"							
68727	3.1/16"							
68728	3.1/8"							
68729	3.3/16"							
68730	3.1/4"							
68731	3.5/16"							
68732	3.3/8"							
68733	3.7/16"							
68734	3.1/2"							
68735	3.9/16"							
68736	3.5/8"							
68737	3.11/16"							
68738	3.3/4"							
68739	3.13/16"							
68740	3.7/8"							
68741	3.15/16"							
68742	4"							
58030	4.1/8"							
58031	4.3/16"							
58032	4.1/4"							
58033	4.5/16"							
58034	4.3/8"							
58035	4.7/16"							
58036	4.1/2"							
58037	4.5/8"							
58038	4.3/4"							
58039	5"							

Cr-Mo DIN 3129

Cr-Mo DIN 3129



SERIE LARGA

1.1/2"

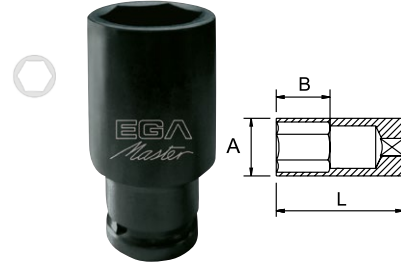
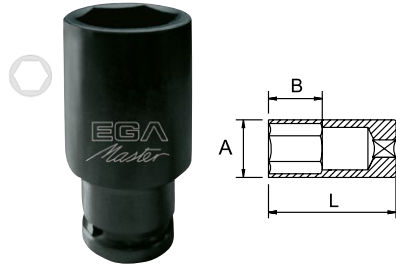

MM

COD	AF	L	A	B	C	Kg.	
56100	34mm						
56101	35mm						
56102	36mm		60			2,8	
56103	38mm					2,9	
56104	40mm	120		31		3,0	
56105	41mm		70			3,2	
56106	42mm					3,3	
56107	43mm					3,8	
56108	46mm					4,0	
56109	50mm		80	33		4,5	
56110	55mm	150	85	36		5,0	
56111	60mm		90	39		5,5	
56112	65mm		95			6,5	
56113	70mm		105	40		7,0	
56114	75mm	170	110			7,5	
56115	77mm		115	42		8,0	1
56116	80mm					8,5	
56117	85mm		120	50		9,0	
56118	90mm	180	130	55		9,5	
56119	95mm		135			10	
56120	100mm		140			11	
56121	105mm		145	60		14	
56122	110mm		155			16	
56123	115mm	190	160			18	
56124	120mm		165	75		19	
56125	125mm		175			21	
56126	130mm		180			22	
56127	135mm		185	80		23	
56128	140mm	200	190			24	
56129	145mm		195			25	
56130	150mm		200	85			

Cr-Mo DIN 3129

INCH

COD	AF	L	A	B	C	Kg.	
58041	1.5/16"	120	62	31		2,7	
56131	1.3/8"					2,8	
56132	1.7/16"		65			2,9	
56133	1.1/2"					3,0	
56134	1.9/16"	120	70	31		3,1	
56135	1.5/8"					3,2	
56136	1.11/16"					3,8	
56137	1.3/4"					4,0	
56138	1.13/16"		75			4,5	
56139	1.7/8"					5,0	
56140	1.15/16"			33		5,5	
56141	2"					6,0	
56142	2.1/16"		80	36		6,5	
56143	2.1/8"					7,0	
56144	2.3/16"	150	85			7,5	
56145	2.1/4"					8,0	
56146	2.5/16"		90			8,5	
56147	2.3/8"					9,0	
56148	2.7/16"			39		9,5	
56149	2.1/2"		95			10	
56150	2.9/16"					10,5	
56151	2.5/8"					10,9	
56152	2.11/16"		100	40		11,2	
56153	2.3/4"					11,7	
56154	2.13/16"	170	105			12,1	
56155	2.7/8"					12,6	
56156	2.15/16"					13,1	
56157	3"	190	110	42		13,6	1
56158	3.1/16"					14	
56159	3.1/8"					14,5	
56160	3.3/16"		115			15,8	
56161	3.1/4"					17	
56162	3.5/16"		120	50		18	
56163	3.3/8"						
56164	3.7/16"		125				
56165	3.1/2"					9,0	
56166	3.9/16"	180	130	55		9,5	
56167	3.5/8"					10,0	
56168	3.11/16"					10,5	
56169	3.3/4"		135			10,9	
56170	3.13/16"					11,2	
56171	3.7/8"					11,7	
56172	3.15/16"		140			12,1	
56173	4"					12,6	
58042	4.1/16"		143			13,1	
58043	4.1/8"		146			13,6	
58044	4.3/16"		148	60		14	
58045	4.1/4"		151			15,8	
58046	4.5/16"	190	153			17	
58047	4.3/8"		156			18	
58048	4.1/2"		160				
58049	4.5/8"		163				
58050	4.3/4"		166	77			

Cr-Mo DIN 3129



LLAVES DE VASO DE IMPACTO

2.1/2"

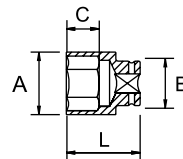
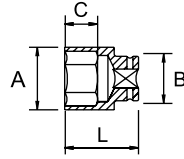

MM

INCH

COD	AF	L	A	B	C	Kg.
68817	41mm					
68818	42mm					
68819	46mm					
68820	50mm	120			36	
68821	55mm					7,5
68822	60mm					
68823	65mm					
65452	70mm				40	
65453	75mm	125				
65454	80mm				45	8,0
65455	85mm					8,5
65456	90mm	130			50	9,0
65457	95mm					11
65458	100mm	140			55	
65459	105mm	145			60	13
65460	110mm	155			65	
65461	115mm	160				15
65462	120mm	160			70	16
65463	125mm	165	180	130		18
65464	130mm	170	185		75	19
65465	135mm	175	190			
65466	140mm	180	200		80	20
65467	145mm	185				
65468	150mm	190	210		85	21
65469	155mm	195	220			25
65470	160mm	200	230		90	28
65471	165mm					30
65472	170mm	210	240		95	32
65473	175mm					35
65474	180mm		250			37
65475	185mm	220	260		110	40
65476	190mm		270			43
65477	200mm					46
68824	205mm		280			49
68825	210mm	230	290		120	55
68826	215mm					60
68827	220mm		300			
68828	225mm		310			65

Cr-Mo DIN 3129

COD	AF	L	A	B	C	Kg.
68744	2"					
68745	2.1/16"				90	
68746	2.1/8"					
68747	2.3/16"				95	
68748	2.1/4"					
68749	2.5/16"	120			36	7,5
68750	2.3/8"				100	
68751	2.7/16"					
68752	2.1/2"					
68753	2.9/16"				105	
68754	2.5/8"					
68755	2.11/16"					40
68756	2.3/4"	110				7,6
68757	2.13/16"					
68758	2.7/8"				115	
68759	2.15/16"					7,7
68760	3"	125	120		45	
68761	3.1/16"					
68762	3.1/8"					7,8
68763	3.3/16"	125				
68764	3.1/4"					
68765	3.5/16"				50	8,4
68766	3.3/8"	130	130			
68767	3.7/16"					
68768	3.1/2"	130				
68769	3.9/16"				135	8,8
68770	3.5/8"					
68771	3.11/16"					55
68772	3.3/4"	140	140			11
68773	3.13/16"					
68774	3.7/8"	140	145			
68775	3.15/16"				150	
68776	4"					60
68777	4.1/16"					
68778	4.1/8"	145	155		130	13
68779	4.3/16"					
68780	4.1/4"					65
68781	4.5/16"	155	160			
68782	4.3/8"					
68783	4.1/2"					15
68784	4.9/16"	160	165			
68785	4.5/8"				170	70
68786	4.11/16"					
68787	4.3/4"				175	16
68788	4.13/16"					
68789	4.7/8"	165	180			75
68790	4.15/16"					18
68791	5"	170	185			19
68792	5.1/4"					
68793	5.5/16"	175	190			80
68794	5.3/8"					
68795	5.1/2"	180	200			20
68796	5.3/4"					
68797	6"	185	210			85
68798	6.1/4"		220			
68799	6.5/16"	200	230			90
68800	6.3/8"					
68801	6.1/2"					30
68802	6.3/4"	210	240			32
68803	7"					35
68804	7.1/4"		250			110
68805	7.5/16"					
68806	7.3/8"	220	260			40
68807	7.1/2"					
68808	7.3/4"		270			43
68809	8"		280			49
68810	8.1/4"				120	55
68811	8.5/16"	230	290			
68812	8.3/8"					60
68813	8.1/2"					
68814	8.3/4"		300			
68815	9"					65

Cr-Mo DIN 3129



LLAVES DE VASO DE IMPACTO

3.1/2"



COD	AF	L	A	B	C	Kg.
67500	100mm		170			16
67501	105mm	180	175		100	17
67502	110mm		185			21
67503	115mm	200	190		115	24
67504	120mm		195			25
67505	125mm		200	180	120	28
67506	130mm	210	210			30
67507	135mm		220		125	34
67508	140mm				130	37
67509	145mm	220	230			39
67510	150mm		240		135	43
67511	155mm				140	45
67512	160mm		250			50
67513	165mm	230	260		145	55
67514	170mm			200		60
67515	175mm		270		150	65
67516	180mm	240	280			70
67517	185mm		290		155	70
67518	190mm		300			80
67519	195mm				160	85
67520	200mm	250	310			90
67521	205mm		320		165	95
67522	210mm		330			105
67523	215mm				170	110
67524	220mm	260	340		175	115
67525	225mm			230		120
67526	230mm		350		185	125
67527	235mm	270	360			130
67528	240mm		370		190	135
67529	245mm				195	140
67530	250mm	280	380			145
67531	255mm		390		200	150
67532	260mm					
67533	265mm	290	400			
67534	270mm		410			
67535	275mm		420			
67536	280mm	300	430			

Cr-Mo DIN 3129

COD	AF	L	A	B	C	Kg.
68830	4"		170			16
68831	4.1/16"		175			17
68832	4.1/8"	180	180		100	21
68833	4.3/16"		185			25
68834	4.1/4"		190			28
68835	4.5/16"		195			30
68836	4.3/8"		200	180	115	34
68837	4.1/2"		210			37
68838	4.9/16"		220		120	43
68839	4.5/8"		230			45
68840	4.11/16"	210	240		125	50
68841	4.3/4"		250		130	55
68842	4.13/16"		260			60
68843	4.7/8"		270		135	65
68844	4.15/16"		280			70
68845	5"		290		140	75
68846	5.1/4"		300		145	80
68847	5.5/16"	220	310		150	85
68848	5.3/8"		320		155	90
68849	5.1/2"		330		160	95
68850	5.3/4"		340		165	100
68851	6"	230	350		170	105
68852	6.1/4"		360		175	110
68853	6.5/16"		370		180	115
68854	6.3/8"		380		185	120
68855	6.1/2"		390		190	125
68856	6.3/4"		400		195	130
68857	7"	240	410		200	135
68858	7.1/4"		420		205	140
68859	7.5/16"		430		210	145
68860	7.3/8"			200		150
68861	7.1/2"				215	155
68862	7.3/4"	250	440		220	160
68863	8"		450		225	165
68864	8.1/4"		460		230	170
68865	8.5/16"		470		235	175
68866	8.3/8"	260	480		240	180
68867	8.1/2"		490		245	185
68868	8.3/4"		500		250	190
68869	9"		510		255	195
68870	9.1/4"	270	520		260	200
68871	9.5/16"		530		265	205
68872	9.3/8"		540		270	210
68873	9.1/2"		550		275	215
68874	9.3/4"	280	560		280	220
68875	10"		570		285	225
68876	10.1/4"	290	580		290	230

Cr-Mo DIN 3129



ADAPTADOR

COD	3/8"	1/2"	3/4"	1"	1.1/2"	2.1/2"	gr.		
60696	3/8-1/2"	-	-	-	-	-	50	6	1
60698	-	1/2-3/8"	-	-	-	-	110		
60699	-	1/2-3/4"	-	-	-	-	130		
60700	-	-	3/4-1/2"	-	-	-	370		
60701	-	-	3/4-1"	-	-	-	410		
60702	-	-	-	1-3/4"	-	-	600		
68698	-	-	-	1"-1.1/2"	-	-	1100		
65448	-	-	-	-	1.1/2"-1"	-	2100		
65449	-	-	-	-	1.1/2"2.1/2"	-	4000		
65478	-	-	-	-	-	2.1/2"-1.1/2"	4500		

DIN 3121



ARTICULACIÓN UNIVERSAL

COD		gr.		
60704	3/8"	80	6	1
60705	1/2"	180		
60706	3/4"	600		
60707	1"	1250		
60708	1.1/2"	3000		
60709	2.1/2"	6000		

DIN 3121



ALARGADERA

COD	3/8"	1/2"	3/4"	1"	1.1/2"	gr.		
60710	75	-	-	-	-	80	6	1
60711	-	125	-	-	-	220		
60713	-	250	-	-	-	430		
57368	-	-	100	-	-	450		
60714	-	-	175	-	-	850		
57369	-	-	250	-	-	1050		
60716	-	-	-	175	-	1500		
57402	-	-	-	250	-	1850		
60717	-	-	-	330	-	2550		
65450	-	-	-	-	250	5500		
65451	-	-	-	-	300	6500		

DIN 3121



ANILLA DE SEGURIDAD

COD	3/4"	1"	1.1/2"	2.1/2"	gr.	
60724	19-46	-	-	-	5,0	6
60725	50	-	-	-		
63274	-	24-38	-	-		
60726	-	38-70	-	-		
60727	-	75	-	-		
60783	-	-	34-150	-		
63275	-	-	-	41-70		
60784	-	-	-	70-200		
63276	-	-	-	200-225		



PASADOR DE SEGURIDAD

COD	3/4"	1"	1.1/2"	2.1/2"	gr.	
60732	19-46	-	-	-	10	6
60733	50	-	-	-		
63277	-	24-38	-	-		
60734	-	38-70	-	-		
60735	-	75	-	-		
60767	-	-	34-150	-		
63278	-	-	-	41-70		
60768	-	-	-	70-200		
63279	-	-	-	200-225		



JUEGO MM

1/2"

COD	pcs.		Kg.
60693	10	13-14-16-17-19-21-22-24-27-30mm	3,5
61265		10-11-12-13-14-17-19-21-22-24mm	3,0

SERIE LARGA

COD	pcs.		Kg.
61266	10	10-11-12-13-14-17-19-21-22-24mm	4,0



JUEGO MM

3/4"

COD	pcs.		Kg.
60694	8	26-27-29-30-32-34-36-38mm	5,0
61269		21-22-24-27-30-32-36-41mm	5,0

SERIE LARGA

COD	pcs.		Kg.
61270	8	21-22-24-27-30-32-36-41mm	6,0



JUEGO MM

1"

COD	pcs.		Kg.
61273	9	24-27-30-32-36-38-41-46-50mm	7,5

SERIE LARGA

COD	pcs.		Kg.
61274	9	24-27-30-32-36-38-41-46-50mm	7,5



JUEGO INCH

1/2"

COD	pcs.		Kg.
61267	11	3/8"-7/16"-1/2"-9/16"-5/8"-11/16"-3/4"-13/16"-7/8"-15/16"-1"	3,2

SERIE LARGA

COD	pcs.		Kg.
61268	11	3/8"-7/16"-1/2"-9/16"-5/8"-11/16"-3/4"-13/16"-7/8"-15/16"-1"	4,2



JUEGO INCH

3/4"

COD	pcs.		Kg.
61271	8	1"-1.1/16"-1.1/8"-1.1/4"-1.5/16"-1.3/8"-1.7/16"-1.1/2"	5,0

SERIE LARGA

COD	pcs.		Kg.
61272	8	1"-1.1/16"-1.1/8"-1.1/4"-1.5/16"-1.3/8"-1.7/16"-1.1/2"	6,0



JUEGO INCH

1"

COD	pcs.		Kg.
61275	9	1"-1.1/8"-1.1/4"-1.5/16"-1.1/2"-1.5/8"-1.3/4"-1.7/8"-2"	7,5

SERIE LARGA

COD	pcs.		Kg.
61276	9	1"-1.1/8"-1.1/4"-1.5/16"-1.1/2"-1.5/8"-1.3/4"-1.7/8"-2"	7,5



CARACTERÍSTICAS TÉCNICAS

MATERIAL	Cr-Mo/Cr-V
DUREZA MÍNIMA	42-44 HRc
ACABADO	Fosfatado

GARANTIA ILIMITADA*