

CASQUILLO CLAMP SOLDAR  
 WELDING CLAMP  
 FERRULE CLAMP À SOUDER

FIG.1712

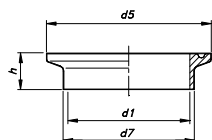

CASQUILLO CL SOLD. CORTO  
 SHORT WELDING CLAMP  
 FERRULE CL SOUDER  
 COURTE.

FIG.1722

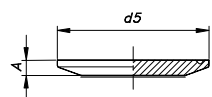

CASQUILLO CIEGO CLAMP  
 BLIND LINER CLAMP  
 BOUCHON CLAMP

FIG.1732

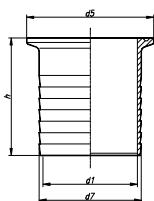

MANGUITO MANGUERA CLAMP  
 HOSE LINER CLAMP  
 MANCHON PORTUYAU  
 FLEX.CLAMP

FIG.1772

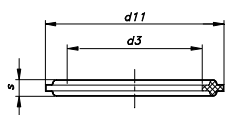

JUNTA RACORD CLAMP  
 GASKET  
 JOINT RACCORD CLAMP

FIG.1708

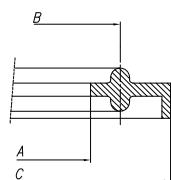

JUNTA RACORD CLAMP CON LAVIO  
 UNION CLAMP SEAL WITH LIP  
 JOINT RACCORD CLAMP AVEC LÈVRE

FIG.1708L

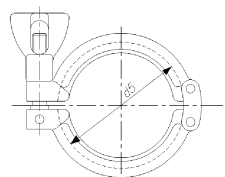

ABRAZADERA  
 CLAMP HEAVY  
 COLLIER CLAMP FORGE

FIG.1703

- >> RACORES CLAMP OD
- >> UNIONS CLAMP OD
- >> RACCORDS CLAMP OD



CASQUILLO CLAMP SOLDAR (PULGADAS)  
WELDING CLAMP (INCHES)  
FERRULE CLAMP À SOUDER (POUCES)

DN	d1	d7	d5	h	AISI 304L	AISI 316L
1"	22,1	25,4	50,5	28,6	1712100	21712100
1½"	34,8	38,1	50,5	28,6	1712112	21712112
2"	47,5	50,8	64	28,6	1712200	21712200
2½"	60,2	63,5	77,5	28,6	1712212	21712212
3"	72,9	76,2	91	28,6	1712300	21712300
4"	97,4	101,6	119	28,6	1712400	21712400

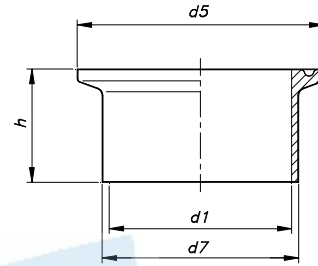

Fig.1712

CASQUILLO CLAMP SOLDAR CORTO  
SHORT WELDING CLAMP  
FERRULE CLAMP À SOUDER COURTE

DN	d1	d7	d5	h	AISI 304L	AISI 316L
½"	9,5	12,7	25,4	12,7	1722012	21722012
¾"	15,8	19	25,4	12,7	1722034	21722034
1"	22,1	25,4	50,5	12,7	1722100	21722100
1½"	34,8	38,1	50,5	12,7	1722112	21722112
2"	47,5	50,8	64	12,7	1722200	21722200
2½"	60,2	63,5	77,5	12,7	1722212	21722212
3"	72,9	76,2	91	12,7	1722300	21722300
4"	97,4	101,6	119	15,8	1722400	21722400

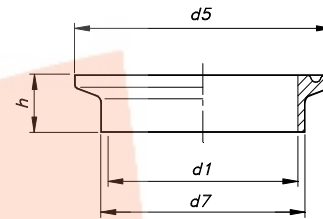

Fig.1722

CASQUILLO CIEGO CLAMP  
BLIND LINER CLAMP  
BOUCHON CLAMP

DN	d5	A	AISI 316L
½"	25,4	5	21732012
¾"	25,4	5	21732012
1"	50,5	6,5	21732100
1½"	50,5	6,5	21732100
2"	64	6,5	21732200
2½"	77,5	6,5	21732212
3"	91	6,5	21732300
4"	119	8	21732400

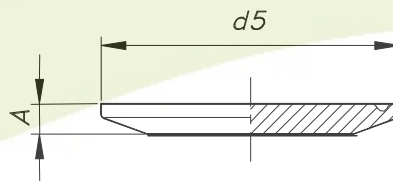

Fig.1732



MANGUITO MANGUERA CLAMP  
 HOSE LINER CLAMP  
 MANCHON PORTUYAU FLEX.CLAMP

DN	d1	d7	d5	h	AISI 316L
1"	22,1	26,2	50,5	42,9	21772100
1½"	34,8	39	50,5	42,9	21772112
2"	47,5	51,6	64	58,7	21772200
2½"	60,2	64,3	77,5	59,5	21772212
3"	72,9	77	91	78,6	21772300
4"	97,4	102,5	119	86,5	21772400

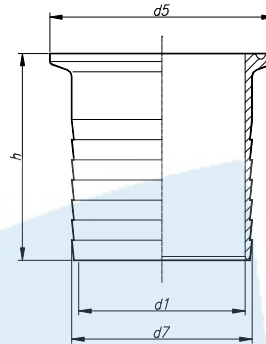

Fig.1772

- Consultar disponibilidad.
- To consult availability.
- Consulter disponibilité.

JUNTA RACORD CLAMP  
 GASKET  
 JOINT RACCORD CLAMP

DN	d3	d11	S	PTFE
1"	22,8	50,5	5,5	1710100
1½"	35,8	50,5	5,5	1710112
2"	48,8	64	5,5	1710200
2½"	60,5	77,5	5,5	1710212
3"	73,1	91	5,5	1710300
4"	97,8	119	5,5	1710400

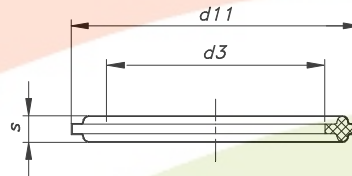

Fig.1708

JUNTA RACORD CLAMP CON LAVIO  
 UNION CLAMP SEAL WITH LIP  
 JOINT RACCORD CLAMP AVEC LÈVRE

DN	A	B	C	MVQ	FPM	NBR	EPDM
1"	22,8	43,5	50,5	1704100	1706100	1707100	1708100
1½"	35,8	43,5	50,5	1704112	1706112	1707112	1708112
2"	48,8	56,5	64	1704200	1706200	1707200	1708200
2½"	60,5	70,5	77,5	1704212	1706212	1707212	1708212
3"	73,1	83,5	91	1704300	1706300	1707300	1708300
4"	97,8	110	119	1704400	1706400	1707400	1708400

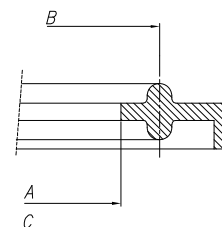

Fig.1708L

- >> RACORES CLAMP OD
- >> UNIONS CLAMP OD
- >> RACCORDS CLAMP OD



ABRAZADERA  
CLAMP HEAVY  
COLLIER CLAMP FORGE

DN	d5	AISI 304L
½"	28	1703012
¾"	28	1703012
1"	53,6	1703100
1½"	53,6	1703100
2"	67	1703200
2½"	80,6	1703212
3"	94	1703300
4"	122	1703400

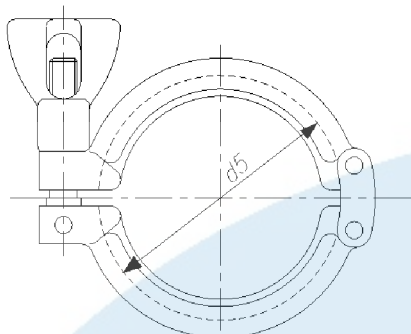

Fig.1703

